

Canon

EOS 40D

DIGITAL

WHITE PAPER



**THE CANON
EOS 40D CAMERA:**

**THE SPIRIT OF
PHOTOGRAPHY**

Table of Contents	I. OVERVIEW	3
	II. SUMMARY OF NEW AND IMPROVED FEATURES	4
	III. PERFORMANCE	5
	New 10.1 Megapixel Sensor	5
	DIGIC III and 14-bit A/D Conversion	6
	Image Recording and Processing	6
	Auto ISO	7
	High ISO Noise Reduction	8
	Highlight Tone Priority	8
	White Balance	9
	Auto Brightness and Contrast Correction	9
	EOS Integrated Cleaning System	9
	AF and New Autofocus Sensor	10
	Drive	12
	Shutter	13
	New Viewfinder and Interchangeable Focusing Screens	13
	Live View Function	14
	Exposure Control	18
	Flash	18
	LCD Monitor	19
	Design and Construction	19
	IV. CONVENIENCE	22
	Basic Operation Concepts	22
	Camera Setting Display	22
	Menu Setting Display	23
	Playback Display	23
	My Menu	24
	Camera User Settings	24
	AF-ON Button	24
	Picture Style Button	24
	Customization	24
	Camera Direct Printing	25
	Interface	25
	Power: Sources and Management	25
	V. SOFTWARE	26
	Settings that can be adjusted in Picture Style Editor	26
	VI. ACCESSORIES AND LENS	31
	• Battery Grip BG-E2N	31
	• Wireless File Transmitter WFT-E3A	32
	• Focusing Screen Ef	33
	• New IS Lens	34
	VII. SPECIFICATIONS	37
	VIII. FEATURE COMPARISON CHART	41
	IX. CONCLUSION	44

I. OVERVIEW

The new Canon EOS 40D welcomes users to the next generation of Digital SLR photography by continuing the Canon traditions of exceptional performance, quality and value. The EOS 40D has a newly-enhanced 10.1 megapixel CMOS sensor that takes advantage of Canon-developed manufacturing techniques to achieve fine detail, high image quality, and low noise. The output from the sensor is converted to 14 bits, rather than 12, for finer color gradation. Highlight Tone Priority improves exposures in difficult lighting conditions.

The EOS 40D is really fast, too. It fires those 10.1 megapixel, 14-bit files at 6.5 frames per second, shooting continuously with 75 shot bursts of Large/Fine JPEGs or 17 RAW images. The speed comes from the powerful combination of the new DIGIC III processor, DDR SDRAM high-speed memory, 4-channel per line sensor readout, and 2 separate motors for shutter and mirror operation. The EOS 40D has a top shutter speed of 1/8000 sec., X-sync at 1/250 sec., a 0.15 sec. startup time and ISOs to 3200 (using the extension feature). High ISO noise reduction maintains image quality with low-light shooting.

The EOS 40D is accurate. It has a completely new AF sensor with 9 cross-type AF points and an innovative center AF point sensitive to vertical and horizontal lines at f/2.8.

Live View Function opens up a whole range of new possibilities for camera operation and placement, either looking at the camera's new, large 3.0-in. LCD monitor, or viewing and firing remotely using the new Wireless File Transmitter WFT-E3A.

The EOS 40D is easy to use and eminently convenient. It has a bright, high-magnification viewfinder with a broad field of view. The Self Cleaning Sensor Unit with Dust Delete Data takes care of most dust-related problems. Image display and navigation are now simpler and have more options, and Camera Direct printing has been enhanced.

The EOS 40D is remarkable in its ability to be configured according to the taste and requirements of the user. It has new, interchangeable focusing screens, Picture Style settings, camera setting registration, an AF Start button, and a host of Custom Functions. Moreover, the EOS 40D's magnesium alloy body and stainless steel chassis make it rugged and feel great in the hand.

The 40D is a camera that will appeal to a vast range of photographers from advanced amateurs to working photojournalists and wedding photographers. All will appreciate its exceptional image quality, ease of operation, speed, modest weight and size, compatibility with the vast Canon system and very reasonable price. This paper will examine the EOS 40D in detail and show exactly why it is such an important and appealing product.

II. SUMMARY OF NEW AND IMPROVED FEATURES

- 10.1-megapixel CMOS sensor (APS-C size) with improved microlenses for superior image quality
- DIGIC III with 4-channel reading for fine image detail, natural colors and faster processing and writing
- 14 bit A/D conversion yields finer gradation, more colors
- Approx. 6.5 fps continuous shooting, maximum burst 75 shots in JPEG (Large/Fine, high-speed continuous mode) or 17 shots in RAW
- Newly-developed AF sensor with 9 cross-type AF points
- Center AF point sensitive to vertical and horizontal lines at f/2.8
- New AF Start button
- Live View Function (Silent shooting mode provided)
- Brighter, sharper viewfinder optics and larger pentaprism yield 0.95x magnification, 26.4° angle of view and 22mm eyepoint
- New interchangeable focusing screens, one with grid lines and one with easy-to-see point of focus
- 3.0-in., fine-detail LCD monitor with 230,000 pixels, a wide viewing angle (approx. 140° vertical and horizontal), larger menu text size and 7 levels of brightness adjustment
- Support for convenient sRAW file format
- New Picture Style button
- Improved noise reduction, especially with long exposures and high ISO speeds
- Auto ISO in Creative Zone modes
- Auto brightness and contrast correction in Basic Zone modes
- Data writing continues even if one opens the CF card slot cover while data is being written to the CF card
- High degree of customization with up to 3 sets of camera user settings, 24 Custom Functions with 62 settings, My Menu and Flash Custom Functions
- More advanced PictBridge features preview of printing effects and tilt correction ($\pm 10^\circ$ in 0.5° increments)
- Highlight Tone Priority function
- Self Cleaning Sensor Unit
- Dust Delete Data obtained and appended to image
- Upgraded dust and weather seals
- Self-timer now 10 sec. or 2 sec.
- Compatible with external recording media and GPS device (via accessory WFT-E3A)
- With external recording media, image recording can switch automatically between different recording media, can be recorded separately to different media or can be recorded simultaneously to multiple recording media
- Images in the CF card can be backed up to external recording media
- Compatible with original data verification system (via WFT-E3A)
- Set Speedlite settings with the camera (with 580EX II Speedlite)
- New, compact EF-S 18–55 mm f/3.5–5.6 IS lens with in-lens Optical Image Stabilizer

III. PERFORMANCE

New 10.1 Megapixel Sensor

The CMOS sensor in the EOS 40D has been designed and developed by Canon, and is made by Canon using semiconductor manufacturing equipment that was also designed and manufactured by Canon. The performance and value benefits that result from this integration are enormous. The EOS 40D boasts the highest performance in its class: approximately 10.1 megapixels, ISOs from 100–1600* in 1/3 steps plus 3200, high-speed signal reading with 6.5 fps shooting, Live View Function silent shooting mode with electronic 1st-curtain shutter, and much more.

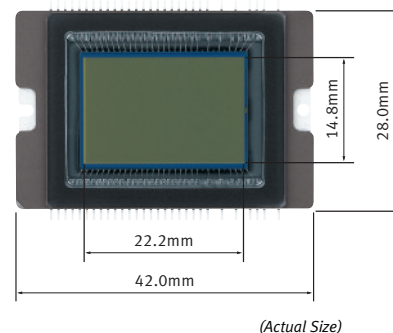

* Standard output sensitivity. Recommended exposure index.

Although the EOS 40D’s single-piece CMOS sensor is based on the Canon EOS Digital Rebel XTi’s sensor design and manufacturing technology, new processes were incorporated in the CMOS semiconductor fabrication and microlens-forming process. By improving light-collecting efficiency, the same ISO range and low noise (S/N ratio) as that of the EOS 30D were attained even though the pixels on the 30D are larger.

ISO Speed and Pixel Size

Camera	Pixels Size	ISO Speed
EOS 40D	5.7µm	100–1600, 3200
EOS 30D	6.4µm	100–1600, 3200
EOS DIGITAL REBEL XTi/ 400D DIGITAL	5.7µm	100–1600
EOS-1Ds Mark III	6.4µm	50, 100–1600, 3200
EOS-1Ds Mark II	7.2µm	50, 100–1600, 3200

The combination of 4-channel reading per line and high-speed signal reading (about twice as fast as the EOS 30D, which also has 4-channel reading), together with a redesigned 2 motor system for charging the reflex mirror and shutter independently (see page 13), enables approximately 6.5 fps continuous shooting.

DIGIC III and 14-bit A/D Conversion

Following its appearance on the EOS-1D Mark III (in tandem form), the EOS 40D also uses Canon’s latest image processor, the DIGIC III. It retains the DIGIC II’s widely admired image detail, natural colors and high speed, while providing 1.7 times faster signal processing speed.

The analog output signal from the imaging element is converted into a digital signal with 14 bits (16,384 colors) per channel instead of the previous 12 bits (4,096 colors). The result is digital data with finer gradation. With RAW/sRAW images recorded at 14 bits, one can use Canon DPP (Digital Photo Professional) software to process and save the image as a 16-bit TIFF image. This yields the maximum range of colors afforded by 14-bit processing. Also, because images recorded in JPEG (8 bits per color) are also generated from 14-bit RAW data, there are fewer blown highlights than before and gradation is excellent. Even in the case of highly saturated subjects or subjects with high contrast and clear differences between light and dark features, high quality color reproduction and smooth tone rendition from highlights to shadows are possible.

Image Recording and Processing

When compared to the EOS 30D, the image quality of the EOS 40D is appreciably better. Resolution is now higher, with approximately 10.1 megapixels versus the 8.2 megapixels of the EOS 30D. Image quality is higher because of the DIGIC III and 14-bit image processing. Noise reduction of high ISO shots, first offered on the EOS-1D Mark III, is enabled via C.Fn II-2. Highlight Tone Priority (ISO range 200-1600*), makes gradation finer from grays to highlights, reducing the likelihood of blown high values. This feature, too, first appeared on the EOS-1D Mark III. It is set on the EOS 40D via C.Fn II-3.

* Standard output sensitivity. Recommended exposure index.

On the image-recording quality selection screen, when one selects the image-recording quality, the respective pixel count (horizontal x vertical) and the number of shots possible with the current CF card are now displayed as well. Also, sRAW (approximately 2.50 megapixels), another feature from the EOS-1D Mark III, has been added as a highly useful image-recording quality option.

Quality Selection Screen

Selected image-recording quality and the respective pixels are displayed

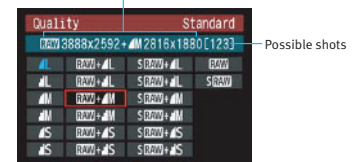

Small RAW can also be recorded simultaneously with any JPEG recording quality. For image size and number of possible shots with their respective image-recording settings, see the chart given here.

Image-recording Quality	Image File Size [Approx. MB]	Possible Shots [Approx.]	Maximum Burst [Approx.]	
			High-Speed	Low-Speed
L (Large/Fine)	3.5	274	75	205
L (Large)	1.8	523	171	523
M (Medium/Fine)	2.1	454	140	454
M (Medium)	1.1	854	303	854
S (Small/Fine)	1.2	779	271	779
S (Small)	0.7	1451	625	1451
RAW	12.4	76	17	20
L (Large)	12.4+3.5	59	14	16
L (Large)	12.4+1.8	66	14	16
RAW+ M (Medium)	12.4+2.1	65	14	16
M (Medium)	12.4+1.1	70	14	16
S (Small)	12.4+1.2	69	14	16
S (Small)	12.4+0.7	72	20	16
sRAW	7.1	135	17	34
L (Large)	7.1+3.5	90	17	21
L (Large)	7.1+1.8	107	17	22
sRAW+ M (Medium)	7.1+2.1	103	17	22
M (Medium)	7.1+1.1	116	17	23
S (Small)	7.1+1.2	115	17	24
S (Small)	7.1+0.7	124	17	25

The number of possible shots (battery life) and continuous shooting speed are based on Canon’s testing standards and a 1GB CF card. The size of one image, number of possible shots (battery life), and continuous shooting speed are based on JPEG quality 8, ISO 100, and the Standard Picture Style. (These figures vary depending on the subject, memory card brands, ISO speed, Picture Style, etc.)

The Picture Style function has the same specifications as those of the EOS 30D, but the EOS 40D is also compatible with Canon's new Picture Style Editor software, which allows even more control over image quality (see page 26 for details). The EOS 40D has a separate Picture Style selection button to the left of the power switch to make selection easier. Next to the Picture Style button is the INFO. button which accesses the parameter setting screen. The buttons improve the ease of selecting and adjusting the Picture Style.

Picture Style Screen

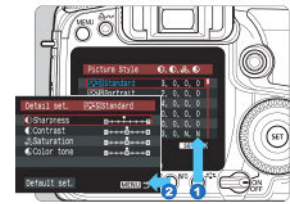

CF card access speed is now 1.7 times faster, thanks to DIGIC III Image Processor, and additional measures have been taken to keep image data intact while it is being written to the memory card. With the EOS 30D, if one opens the CF card slot cover while data is being written to the CF card, image data would be erased. However, with the EOS 40D (and the EOS-1D Mark III), data writing continues even if the CF card slot cover is opened. If the slot cover is opened, the beeper will sound and a warning screen will be displayed until the cover is closed.

Open-cover Warning Screen



Also, if the power switch is turned off while data is being written to the CF card, a warning screen is displayed during the writing. When the writing ends, the camera turns off.

During image deletion, images to be discarded are marked with checks. A useful new function permits the deletion of all checked images simultaneously.

As with the EOS-1D Mark III, image recording can be set to [Standard], [Auto switch media], [Rec. separately], or [Rec. to multiple]. The optional settings are used when an additional USB storage device is connected to the EOS 40D via Wireless File Transmitter WFT-E3A (see page 32).

Recording Function

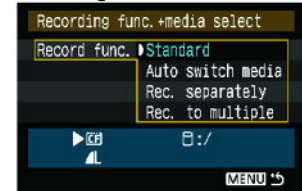

Images in the CF card can be backed up to external media via the WFT-E3A as mentioned above. Besides the quick backup feature also found in the EOS-1D Mark III, the folder to back up the images can be created or selected. Only checkmarked images can be backed up.



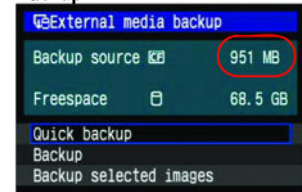



Backup



Auto ISO

A new feature, Auto ISO speed, is enabled in the Creative Zone modes. When the ISO is set to [Auto], ISO 400 is set initially. Then, depending upon the lighting conditions, ISO speed is selected automatically (in 1/3-stop or whole-stop increments) as shown in the accompanying table. The resulting shutter speed is a function of the brightness level such with an aim towards reducing blur caused by camera shake, and also to ensure that the subject does not appear too bright or too dark because of overexposure or underexposure.

[Auto] ISO Speed Settings

Shooting mode		ISO Speed Settings
Creative Zone modes	P/Av/A-DEP	Set within ISO 400-800 so that the respective shutter speed will not cause camera shake under the current lighting conditions. If overexposure will result at ISO 400, a lower ISO speed, as low as ISO 100, is set.
	Tv	If overexposure or underexposure will result at ISO 400, the ISO speed is shifted within 100-800. (=EOS-1D Mark III's. C.Fn I-8-2)
	M	Fixed at ISO 400.
Basic Zone modes	  	Automatically set within ISO 100-800, according to the brightness.
	  	Automatically set within ISO 100-800, according to the brightness.
		Fixed at ISO 100.
With flash		Set to ISO 400 in all shooting modes. If overexposure would result in fill-in flash, a lower ISO speed, as low as ISO 100, will be set.

The automatically-set ISO speed is displayed in the viewfinder and on the LCD panel while the metering is active. In the Basic Zone modes, the automatically-set ISO speed range is 100-800,* 1 stop greater on the high end than with the EOS 30D.

* Standard output sensitivity. Recommended exposure index.

High ISO Noise Reduction

Long exposure noise reduction is equal on the EOS 40D and 30D cameras. [Off], [Auto], or [On/always applied] can be selected. The time required for noise reduction processing is equal to the duration of the original exposure; the next photograph cannot be shot until noise reduction processing in progress is complete.

High ISO noise reduction (C.Fn II-2) can be used for images taken at a high ISO speed, as with the EOS-1D Mark III. Although some noise reduction is applied at all ISO speeds, it is particularly effective at high ISO speeds. However, at low ISO speeds, noise in the shadow areas is, in fact, further reduced. Also, when [High ISO speed noise reduction] is set, the maximum burst during continuous shooting will decrease to 8, regardless of the image-recording quality.

Highlight Tone Priority

Highlight Tone Priority seeks to improve highlight detail. The range is extended between 18% ("middle") gray and the maximum highlight tone. This makes the gradation finer from the grays to the highlights and reduces blown highlights. The function limits the settable ISO speed range to 200-1600.*

* Standard output sensitivity. Recommended exposure index.



White Balance The white balance settings are basically the same as those of the EOS 30D. Only the color temperature (P) as a preset WB is new. The lowest manually selectable color temperature has been lowered from 2800K to 2500K in order to cover tungsten light more effectively. One can now register one setting of personal white balance under <O> with the provided software. WB correction and WB bracketing settings can now be canceled with the INFO. button.

Auto Brightness and Contrast Correction In Basic Zone modes, when the image is processed internally (i.e. not RAW or sRAW), image characteristics are detected and are now adjusted automatically during processing to obtain optimized brightness and contrast.

Sample Adjustment of Brightness and Contrast

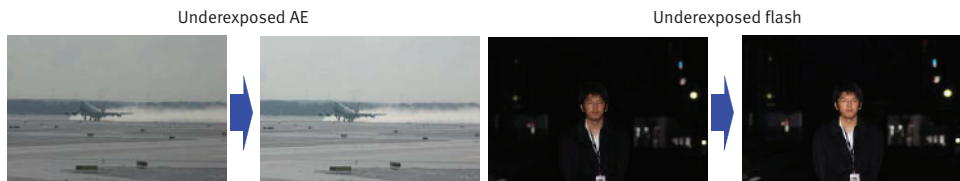

* In bright scenes such as at the beach and on ski slopes, underexposure tends to result. The automatic adjustment makes the highlights brighter, resulting in a more natural looking brightness.

* When the subject is beyond the range of the flash and becomes underexposed, the automatic adjustment makes the highlights brighter. This results in a standard flash exposure.



* In the case of low-contrast, hazy scenes, the contrast is adjusted to obtain a clearer and more distinct image.

EOS Integrated Cleaning System

As in the examples of the EOS-1D Mark III and the EOS Digital Rebel XTi, the EOS 40D incorporates the highly practical EOS Integrated Cleaning System to help prevent dust generation and adhesion of dust to the low-pass filter. Although it is basically the same system as the one employed in the EOS-1D Mark III, the Self Cleaning Sensor Unit is a 3rd-generation design that uses only 1 piezoelectric element instead of 2, and the unit is optimized for the smaller APS-C size instead of the larger APS-H size.

The self-cleaning operation can be executed automatically during power on/off, with an operation time of approximately 1 sec., or manually with an operation time of approximately 3.5 sec. Dust Delete Data is acquired when the coordinates of dust adhering to the low-pass filter are detected by a test shot and appended to subsequent images. The dust coordinate data appended to the image is used by the provided software DPP to erase dust spots automatically. Dust removal performance and Dust Delete Data specifications are the same as those of the EOS-1D Mark III.

The [Sensor cleaning] menu is basically the same as the one in the EOS-1D Mark III. However, there are slight differences such as the shutter operation sequence for [Clean now]. For the EOS-1D Mark III, it is: Cleaning operation -> Shutter cocking -> Cleaning operation -> Shutter cocking -> Cleaning operation. In the EOS 40D, it is: Cleaning operation -> Shutter release -> Cleaning operation.

Unit Construction Diagram

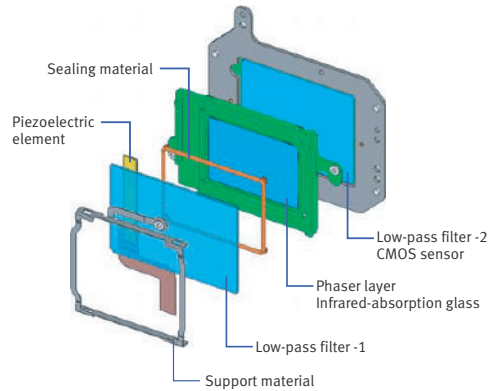

Self Cleaning Sensor Unit

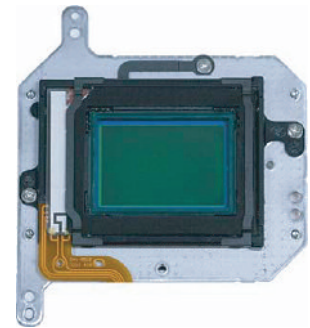

The option of manual sensor cleaning by raising the mirror and using a blower to remove dust is the same as other EOS Digital SLR cameras.

AF and New Autofocus Sensor

A newly-developed AF sensor with 9 cross-type AF points greatly boosts AF performance, improving both AF detection precision and extreme-defocus subject detection capability.

AF Sensor

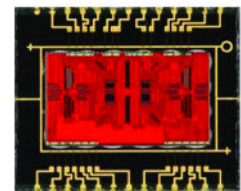

AF sensitivity is now EV -0.5 to EV 18. All AF points work as cross-type points at f/5.6 or better. Both vertical- and horizontal-line sensitive focus detection thus works with any AF point for stable focusing. High-precision AF is attained with fewer AF failures with hard-to-focus subjects. Also, with the sensor pitch reduced from 16µm to 14.4µm, detection performance is more accurate.

Sensor Configuration

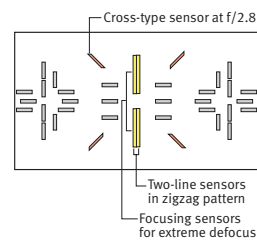

AF Points

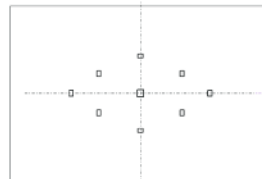

AF Sensor Arrangement

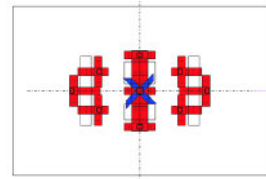

■ Sensor with F2.8 Support
■ Sensor with F5.6 Support

In sum, the newly-developed AF sensor has appreciably higher performance than the EOS 30D's AF sensor.

Specifications Comparison of AF Sensors

	40D	30D
Cross-type sensor	9 (All cross-type)	1 (Center)
high-precision f/2.8 compatibility	cross-type sensor at center	Vertical-line sensitive at center
Extreme-defocus compatibility	Yes	-
EV range [EV]	-0.5 - 18	
Sensor pitch [μm]	14.4	16

AF Point Position and Spacing

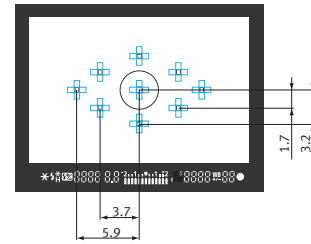

The positioning of the AF points is almost the same as with the EOS 30D's AF sensor.

The center AF point has a cross-type AF sensor sensitive to vertical and horizontal lines at f/2.8. This is a first in an EOS camera. Previously, the central sensor for f/2.8 or better was only vertical-line sensitive. Because the f/2.8 sensor is a diagonal, cross-type sensor, it does not obstruct the f/5.6 sensor positioned vertically at the center.

The upper center, center, and bottom 3 horizontal-line sensitive sensors are in a 2-line, zigzag configuration. With this double focusing system, inconsistent focusing detection is reduced. By using the 2-line focusing sensors described above, a subject in extreme defocus can be detected and AF control is quick and easy.

To attain more stable AF performance than before, the AF unit has more precise AF optics and environment-resistant construction and materials.

AF Unit

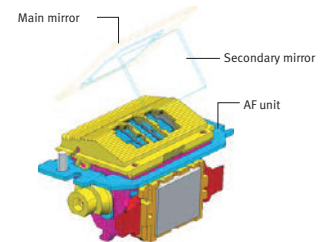

The AF modes are the same as those of the EOS 30D: One-Shot AF, AI Focus AF, and AI SERVO AF. Any of these settings can be selected in Creative Zone shooting modes. One-Shot AF is set automatically in the Portrait, Landscape, Close-up, and Night Portrait modes. AI Focus AF (switches between One-Shot AF and AI SERVO AF automatically) is set automatically in Full Auto and Flash Off modes. Predictive AI Servo AF is set automatically in Sports mode. The EOS 40D can, of course, also be focused manually in any shooting mode.

Compared to the EOS 30D, the EOS 40D's focusing calculation speed is 1.3 times faster, and the AF data-processing time is shorter. Predictive AF can track a subject approaching at 50 kph/31 mph up to about 26.2 ft./8m away with an EF 300mm f/2.8L IS USM lens.

Predictive AF Performance

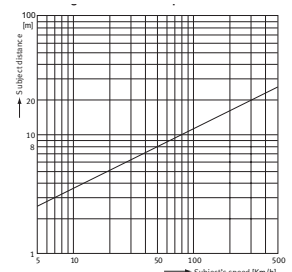

Because subject detection has been improved with all cross-type AF points, high-speed continuous shooting in the AI SERVO AF mode is more stable than with the EOS 30D, and it is also done at a faster framing rate (6.5 fps vs. 5.0 fps).

The algorithm for automatic AF point selection in the EOS 40D is the same as the EOS 30D's. However, because all the AF points are now cross-type sensors, subject detection is improved, making the AI SERVO AF subject-tracking performance better. Also, in the One-Shot AF mode, the probability of capturing the subject as intended is increased.

The EOS 40D can use its built-in flash as an AF Assist beam, by emitting a series of flashes in low light. The effective range is approximately 13.1 ft./ 4m at the center AF point and approximately 11.5 ft./ 3.5m at the eight off-center AF points.

Alternatively, certain accessory

Canon Speedlites, listed in the accompanying table, can emit an AF-assist beam that is more discreet and covers a greater distance range.

AF-assist Beam with External Speedlites

Speedlite	Automatic Selection	Manual Selection			
		Center	Top/Bottom	left/Bottom	Mid-left/Mid-right
580EX II	Yes	Yes	Yes	Yes	Yes
580EX	Yes	Yes	Yes	Yes	Yes
550EX, ST-E2	Yes	Yes	N/A	Yes	Yes
430EX, 420EX	Yes	Yes	Yes	Yes	Yes
380EX, 220EX	Yes*	Yes	N/A	N/A	N/A

*Focus can be achieved only with the center AFpoint.

As with the EOS 30D, one can use the Multi-controller or Main/Quick Control dial (C.Fn III-3-1/2) to select the AF point while looking at the superimposed AF point in the viewfinder or the LCD panel's AF point selection display. Also as with the EOS 30D, the AF mode (One-Shot AF, AI Focus AF, AI SERVO AF) is selectable even in the Creative Zone modes. The provision of an <AF-ON> button is a feature from the EOS-1D Mark III. Alternately, one can press the shutter button half way to activate the AF.

Drive The EOS 40D has the highest continuous shooting speed in its class[†], approximately 6.5 fps in both One-Shot AF and AI SERVO AF modes. Despite increased resolution and its concomitant increase in file size, this exceptional speed and a stable viewfinder image are attained by combining several technologies. The powerful new DIGIC III processor and 4-channel sensor readout have been mentioned here already. The buffer memory of the EOS 40D is DDR SDRAM (double data rate, synchronous dynamic random access memory) for high-speed reading and writing, whereas the EOS 30D used the slower SDRAM.

† As of August 2007.

Of considerable importance, the EOS 40D uses a 2-motor system, one dedicated to driving the mirror, and one dedicated to cocking the shutter speedily. Also, a stopper is incorporated to prevent the rebounding or bouncing of the main mirror and secondary mirror. This results in shorter viewfinder blackout and a more stable viewfinder image during continuous shooting.

Two-Motor System

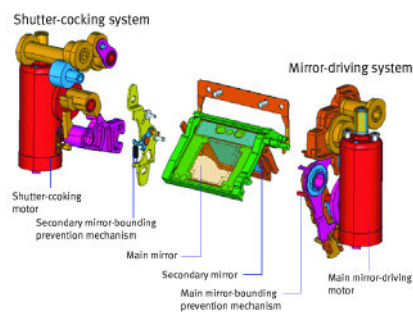

With DIGIC III Image Processor, DDR SDRAM and a circuit design to take advantage of their maximum performance, the maximum burst at approximately 6.5 fps is approximately 75 shots in JPEG Large/Fine and approximately 17 shots in RAW. By comparison, the maximum bursts for the EOS 30D were 30 Large/Fine JPEGs and 11 RAW. (These figures are based on Canon's testing standards with a 1GB CF card. The maximum burst during continuous shooting varies depending on such factors as subject, CF card brand, ISO speed, and Picture Style.)

In Low-speed continuous drive mode, the EOS 40D fires at approximately 3 fps. The drive mode selection loop now includes a 2-sec. self-timer.

Shutter While it is based on the EOS 30D's mechanical shutter unit, the shutter of the EOS 40D is now more reliable with a contactless switch instead of a contact switch for running the 1st and 2nd curtains. Shutter durability is approximately 100,000 cycles, the same as the EOS 30D's shutter. The shutter release lag time with SW-1 ON is approximately 0.059 sec. between SW-2 ON and start of exposure. The time lag between simultaneous SW-1/SW-2 ON and the start of exposure is approximately 0.126 sec. Time lag is calculated with the aperture stopped down 3.5 stops or less and excludes AF operation time. Viewfinder blackout time is about 0.1 sec.

The self-timer now offers a choice of 2 sec. or 10 sec. delay. The shorter time is useful for eliminating blur caused by the camera shake associated with release technique in situations such as landscape or close-up photography. With a fully-charged Battery Pack BP-511A, a bulb exposure can be as long as about 2.5 hours.

Shutter-Release Stroke and Pressure

State	Stroke	Pressure
Shutter button protrusion	1.3mm	-
Standby position to SW-1 ON	0.55mm	140g
SW-1 ON to SW-2 ON	0.3mm	330g

In addition to the mechanical shutter, the EOS 40D has a 1st curtain electronic shutter that is a key component in the Live View Function.

New Viewfinder and Interchangeable Focusing Screens

The EOS 40D has a new, enlarged and optimized pentaprism and a larger diameter eyepiece lens. The viewfinder looks bigger with less vignetting (edge cut-off). To make the viewfinder clearer and easier to see, the magnification is 0.95x, the angle of view is 26.4°, and the eyepoint is 22mm. By comparison, the EOS 30D's viewfinder gave 0.9x magnification, a 25.1° angle of view, and a 20mm eyepoint. On both cameras, the coverage is 95% and the dioptic adjustment is -3 to +1.

Viewfinder Coverage Comparison

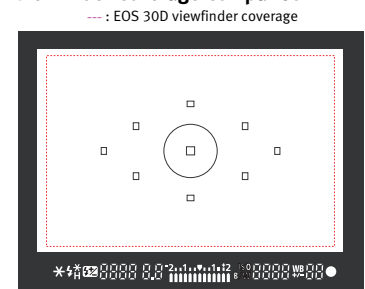

The EOS 40D's 22mm eyepoint is the distance at which the viewfinder image area can be viewed without any vignetting of the viewfinder on all 4 edges. Normally, most manufacturers define the eyepoint as the distance at which both the viewfinder image area and information display are visible. The 22mm specification for the 40D meets both criteria, absence of cut-off as well as visibility of both image and information. The basic configuration of the super-imposed display optics is the same as that of the EOS 30D.

Viewfinder Optics

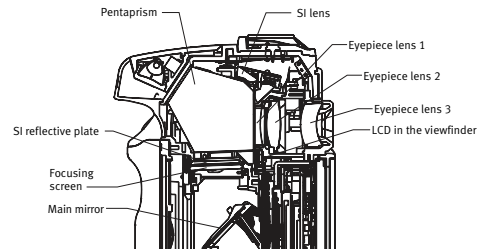

Interchangeable focusing screens are a new and significant feature of the EOS 40D. The Ef-series focusing screens have been newly developed. 3 screens, the Ef-A Standard Precision Matte, the Ef-D Precision Matte with Grid, and the Ef-S Super Precision Matte are available. All 3 focusing screens have a fresnel lens area and are produced by a new molding method (first used on the EOS-1D Mark III's focusing screen Ec-C IV) that provides excellent transfer characteristics. Consequently, even the Standard Precision Matte

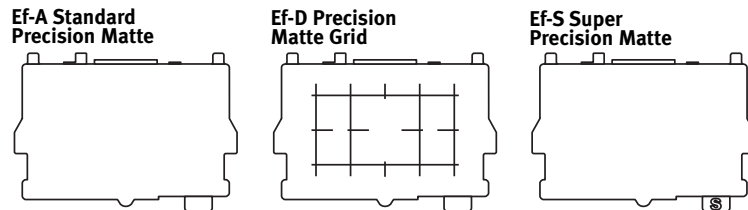

screen offers improved performance. The Grid Type screen is particularly convenient for controlling horizontal positioning and as an aid to overall composition. The Super-Precision screen makes it easier to find the "sweet spot" of focus when using a lens that is faster than $f/2.8$ and is also effective in difficult, manual focus conditions.

The information display inside the finder has been enhanced in several ways: the ISO is always displayed, even when Auto ISO is set; a Black and White setting alert has been added; and the maximum burst possible is displayed in two digits instead of one. The LCD monitor can also be used to display the settings of the shooting functions.

Live View Function

One of the major aspects of the EOS-1D Mark III is the inclusion of a fully-functional Live View Function. The EOS 40D has it as well, along with some useful improvements. In addition to the Live View Function found in the EOS-1D Mark III, the EOS 40D enables "AF during Live View Function" and "Silent shooting." (Note: Live View Function is only possible with the Creative Zone modes.)

The EOS 40D's CMOS sensor has an electronic 1st-curtain shutter function, enabling shooting with the mechanical shutter completely open. With Live View Function image displayed, the 40D can shift seamlessly to slit exposures with the electronic 1st-curtain shutter, enabling silent shooting which is not possible with a mechanical 1st-curtain shutter. This electronic 1st-curtain shutter uses a unique high-speed scanning and electronic reset system that accurately mimics the EOS 40D's high-speed mechanical shutter

operation. It synchronizes with the mechanical 2nd-curtain shutter to obtain a slit exposure. (Note that with CMOS, it is difficult to have an electronic 2nd-curtain shutter. Therefore, only the 1st-curtain shutter is electronic.)

As a result of the electronic 1st-curtain shutter, the [Silent shoot] Modes 1 and 2 make the shutter-release time lag shorter and reduce shutter-cocking noise. Mode 1 enables continuous shooting at approximately 6 fps and is quieter than ordinary, non-Live View shooting. Continuous shooting is not possible with Mode 2. With Mode 2, shutter cocking does not occur after shutter release, but only when the shutter button is SW-2 OFF. At most, only the shutter curtains make noise, and the shutter sound during the exposure can be limited to the quieter mechanical 2nd-curtain shutter. Live View Function with the EOS-1D Mark III had the shutter closing after the shutter release before the start of the exposure. This caused shutter-release time lag and shutter-cocking noise.

Pressing the AF-ON button pauses the Live View Function; the reflex mirror goes down and the camera executes AF. Letting go of the AF-ON button resumes the Live View Function. With C.Fn III-6, the set AF mode and AF point (automatic selection possible) will be applied during AF while one holds down the AF-ON button.

Note that during this time, there will be no Live View Function image displayed since the reflex mirror will be down. Since no AF points are displayed on the screen with Live View Function, positioning the magnified display's focusing frame at the center and selecting the center AF point for autofocus is recommended. During AF operation, shutter release is not possible. One must first release the AF-ON button and wait until the image with Live View Function is displayed, then shoot.

With the CMOS sensor's electronic 1st-curtain shutter, shooting is possible while the image with Live View Function is displayed and the mechanical 1st curtain is open. The mechanical 1st curtain need not be closed in order to shoot. This eliminates the mechanical 1st curtain's shutter sound at SW-2 ON which occurs with the EOS-1D Mark III during Live View Function. Silent shooting is therefore possible.

As in the case of the EOS-1D Mark III's Live View Function, the exposure is controlled with the mechanical shutter's 1st and 2nd curtains. Set to "Disable" when using a TS-E lens shifted up or down or when using an Extension Tube. If one sets Mode 1 or Mode 2 when using a TS-E lens and a shutter speed of 1/2000 sec. or faster, the small slit created between the electronic 1st-curtain shutter and mechanical 2nd-curtain shutter will be in the same orientation as the optical axis, resulting in underexposure or overexposure.

Silent Shooting

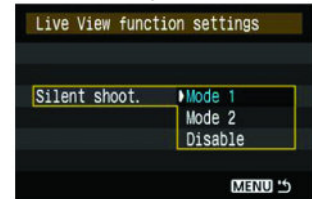

C.Fn III-6

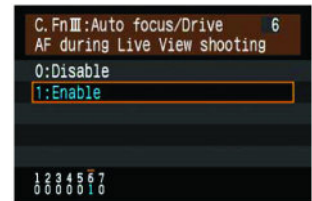

AF During Live View Function



Similarly, with an Extension Tube and a shutter speed of 1/2000 sec. or higher, the exposure will be uneven at the top and bottom of the image.

When using an EX-series Speedlite, the shooting sequence will be the same as the EOS-1D Mark III's Live View Function in either silent shooting Mode 1 or 2. In other words, after pressing the shutter button all the way down to initiate an exposure, the reflex mirror will drop down briefly in order to register the E-TTL II preflash data, then the mirror will be moved out of the optical path during the actual exposure.

TS-E Lens + 1/8000 sec.

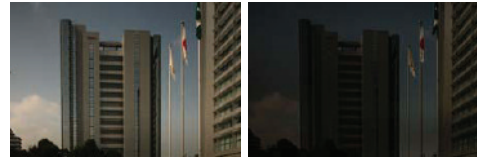

No shift movement

11mm shift up

The Live View Function metering timer is geared mainly for still-life subjects. Live View Function enables the metering timer to be changed to one of 6 settings from 4 sec. to 30 min.

Live View Function Metering Timer

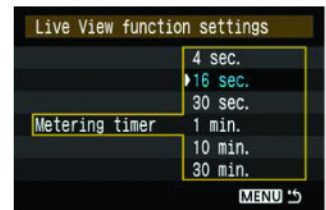

Two useful features of Live View Function in the EOS-1D Mark III that appear in the EOS 40D are:

- Live View Function exposure simulation (via C.Fn IV-7) that displays images on the LCD monitor, simulating the shooting exposure used during Live View Function, with the same shutter speed, aperture and other exposure settings.
- A grid display that can be selected from the Live View function setting menu

Grid Display



During Live View Function, approximately 170 shots are possible at 73°F/23°C and approximately 130 shots are possible at 32°F/0°C with flash used on 50% of the exposures. Without using flash, approximately 180 shots can be made at 73°F/23°C and approximately 140 shots can be made at 32°F/0°C (in both cases, a fully-charged Battery Pack BP-511A is used and CIPA testing standards are observed).

Live View Function Information

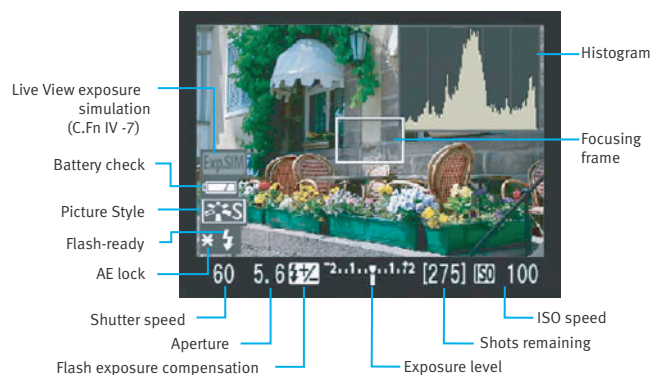

An icon has been added to indicate that exposure simulation has been enabled.

Although this series of white papers generally confines itself to new and improved features, the following summary of Live View Function may be useful:

- Shoot while watching the camera LCD monitor instead of the finder
- Excellent for precise macro focus
- No need to stoop or stretch to look in the finder
- 100% field of view helps control composition
- Short lag time captures near-instantaneous movements
- Type: electronic viewfinder with imaging sensor
- Coverage: approx. 100% vertically and horizontally
- Frame rate: 30 fps
- Focusing:
 - Manual focus: magnify the image by 5x or 10x for precise manual focusing
 - Autofocus: with C.Fn III-6-1, press the <AF-ON> button and the reflex mirror will go back down (Live View Function interrupted). The same phase detection AF measurement as during normal shooting is executed. After focus is achieved, let go of the <AF-ON> button and Live View Function will resume.
- Metering:
 - Real-time evaluative metering with the imaging element
 - AE lock possible
 - Metering range: EV 0–20 (At 73°F/23°C, 50mm f/1.4 lens, ISO 100)
 - The active metering time can be changed
- Exposure confirmation: exposure compensation and AEB simulation possible (C.Fn IV-7-1)
- Depth-of-field preview: possible with Depth-of-field preview button
- Magnified view: magnify by 5x or 10x initially at the center of the picture area; focus frame can be moved to any location in the picture area by scrolling with the multicontroller.
- Grid display: two vertical and two horizontal lattice lines displayable
- On-screen information display:
 - Focus information: Focus Frame
 - Exposure information: Shutter speed, aperture, AE lock, ISO speed, exposure level
 - Captured image information: Picture Style, histogram, shots remaining
 - Battery check icon
- Silent shooting: provided (Mode 1 and Mode 2)
- Possible shooting time: approx. 30 continuous min. (with fully-charged Battery Pack)
- Shutter-release time lag:
 - (1) With SW-1 ON, time lag from SW-2 ON to the start of the exposure: 0.059 sec.
 - (2) With SW-1 and SW-2 pressed simultaneously, time lag until the start of the exposure: 0.126 sec.
 - Time lag figures above apply with the aperture stopped down by up to 3 stops (reflex mirror operation time excluded).
- Remote Live View Function: enabled with EOS Utility, outputs Live View Function video for viewing on computer monitor, improves remote shooting by making it possible to check such things as composition, focus, moiré, and false colors

Exposure Control

The EOS 40D uses the same 35-zone metering sensor as in the EOS 30D. The metering modes are evaluative, partial (approximately 9% of viewfinder area), spot (approximately 3.8% of viewfinder area), and center-weighted average metering.

Metering Sensor

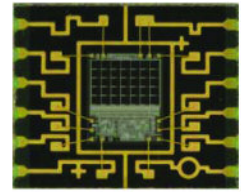

Previously, during automatic AF point selection and AF point-centered evaluative metering, there was a tendency for slightly excessive compensation. The compensation is now looser so that exposure is more consistent.

The E-TTL II autoexposure algorithm of the EOS 40D is the same as the EOS-1D Mark III's E-TTL II autoexposure algorithm. By optimizing the method of using lens distance information, exposure becomes more accurate for highly reflective subjects. With the EOS 30D, the selected metering mode was used to meter the ambient light. This sometimes resulted in inaccurate exposures when the selected metering mode was not evaluative metering. Therefore, as with the EOS-1D Mark III, evaluative metering is now used at all times to meter the ambient light.

The EOS 40D uses the same exposure control system as the EOS 30D, with eleven AE modes and manual mode. While based on the EOS 30D's shutter unit, the 40D's shutter is now more reliable with a contactless switch instead of a contact switch for running the 1st and 2nd curtains. Shutter durability is approximately 100,000 cycles, the same as with the EOS 30D's shutter. With a fully-charged Battery Pack BP-511A, the shutter supports a bulb exposure as long as about 2.5 hours.

Flash

A new feature, shared with the EOS-1D Mark III, and a considerable convenience, is that both built-in flash and external Speedlite settings can be set on the EOS 40D from the camera with the menu screen. With external, EX-series Speedlites, this includes Flash mode, sync setting, FEB, flash exposure compensation, E-TTL II, zoom, wireless flash, and clear settings. The EOS 40D can make communication settings as well, such as communication channel, flash group, and flash brightness when the Speedlite 580EX II is used. Also, with the 580EX II attached to the camera, one can set or cancel the Speedlite's Custom Function settings (C.Fn-0 to 13) with the camera. With an EX-series Speedlite other than the 580EX II, the camera cannot be used to set the Speedlite's Custom Functions.

External flash Custom Function

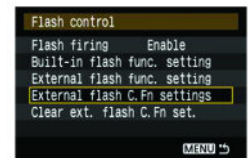

The flash unit in the EOS 40D is the same as the unit in the EOS 30D. Its Guide Number is 43/13 at ISO 100 in feet/meters. Flash coverage is effective for focal lengths 18mm and higher, with some limitations based on the size of the lens. If the built-in flash is fired rapidly in succession, the flash firing will be stopped to prevent heat damage to the built-in flash cover and fresnel lens (diffuser). In the case of the EOS Digital Rebel XTi, which has similar specifications, if the built-in flash is fired 20 times successively at 10 sec. or shorter intervals, the firing will be stopped. With the EOS 40D, the flash control is more precise, so the flash stoppage is less likely to occur than with the EOS Digital Rebel XTi.

[Built-in flash func. setting] is a group with [Flash exp. comp], [Shutter sync], and [E-TTL II] (Evaluative/Averaged metering). The latter 2 were previously Custom Functions. [External flash func. setting] now includes [Wireless set.] from the EOS-1D Mark III's [Flash function settings]. This is to enable wireless, multi-Speedlite control. Also, C.Fn items related to the internal flash, such as flash activation, E-TTL II metering method and flash synch timing, have been collected in the flash setting menu.

Flash Control

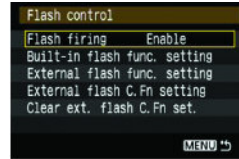

Built-in Flash Control

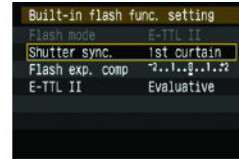

Wireless Flash Control

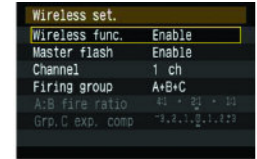

LCD Monitor

The EOS 40D has a 3.0-in. TFT liquid-crystal color LCD monitor with approximately 230,000 pixels and a wide, 140° viewing angle, both horizontally and vertically. Note that the viewing angle has actually been reduced from 170° on the EOS 30D to improve ease of viewing outdoors, and that the screen's brightness level has been increased for the same reason. Also, the color gamut has been broadened. Brightness is adjustable to any of seven levels. The larger monitor size means a larger font size can be used for menu display. In all, the LCD monitor is easier to use and more accurate than before.

Comparison with EOS 30D Screen

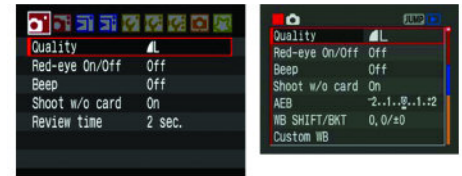

Design and Construction

Like the EOS 30D, the main exterior covers (top, front, and rear) are made of magnesium alloy for light-weight and high strength. The grip portion is integrated with the front cover, enhancing body rigidity further. The body's basic construction is the same as that of the EOS 30D, employing a stainless steel chassis and a mirror box made of high-strength engineering plastic. As with the EOS 30D, the exterior has a high-quality, black satin finish with a non-slip texture. The EOS 40D also has sealing material lining the CF card slot cover and battery compartment cover (which is not found in the 30D) to improve dust- and water-resistance. The EOS 40D has sealing material lining the CF card slot cover and battery compartment cover to improve dust- and water-resistance. The battery compartment covers of both the Battery Grip BG-E2N and the Wireless File Transmitter WFT-E3A have sealing material to improve resistance to dust and water.

Exterior Covers and Internal Construction

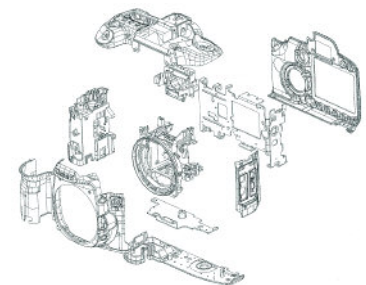

The configuration of the major components is basically the same as in the EOS 30D, with the exception of the following units which have been added or changed:

- Self Cleaning Sensor Unit
- LCD monitor made bigger from 2.5 in. to 3.0 in.
- Two driving motors to attain approximately 6.5 fps continuous shooting speed
- Extension system terminal

The major circuit boards are as follows:

- Main board (digital control circuit and camera control circuit)
- Bottom board (flash circuit and actuator drive circuit)
- Power circuit board

These boards efficiently integrate various control circuits. There are also 23 flexible boards outfitted with the sensor, switches, and so forth.

The main board is a highly integrated, 10-layer unit containing the digital control circuit and the camera control circuit. It includes the following:

- The image signal-processing circuit consisting of ICs such as the A/D IC that converts the CMOS sensor output to a digital signal
- The TG (Timing Generator) that generates the CMOS sensor's drive pulse
- The digital image-processing circuit that has DIGIC III
- The memory circuit that has DDR-SDRAM as the buffer memory
- The TFT liquid-crystal control circuit
- The USB terminal
- The video OUT terminal
- The extension system terminal
- The Main CPU that controls various sensors and mechanical parts for camera operations, viewfinder display, and drive control circuit
- EEPROM memory to store saved data such as adjustment data (AE, AF, etc.)

The bottom board is a highly integrated, 4-layer board containing:

- The flash circuit and actuator drive circuit
- The flash circuit which controls the built-in flash's recycling and firing and the external Speedlite control circuit
- The 2-motor control circuit that drives the mirror and shutter-driving actuator
- The lens power supply control circuit
- The Self Cleaning Sensor Unit's actuator drive control circuit

Major Hard Boards

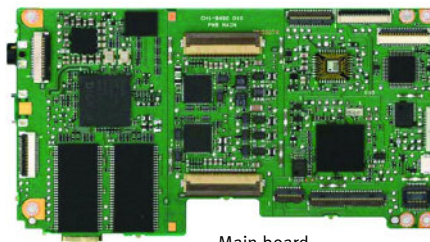

Main board



Power supply board

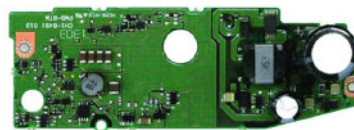

Bottom board

The power circuit board has the circuit that generates and supplies the voltage required by the camera's circuits. The RoHS directive restricts the use of 6 toxic substances: lead, mercury, cadmium, hexavalent chromium, polybrominated biphenyl, and polybrominated diphenyl ether. It applies to products sold in the EU (effective from July 1, 2006). All of the EOS 40D's parts conform to this directive.

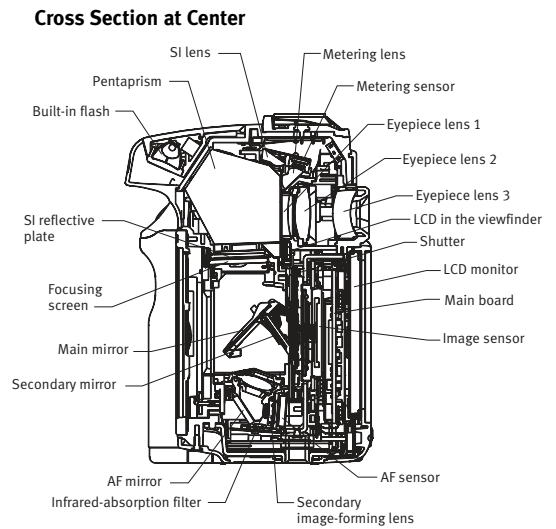

IV. CONVENIENCE

Basic Operation Concepts

While it is grounded in the EOS 30D's basic operation concepts, the EOS 40D has improvements that make it easier to use. The shooting buttons above the LCD panel have been reassigned; an AF Start button (AF-ON) is provided (as with the EOS-1D Mark III), and the Picture Style selection button is new. As much as possible, though, the operation method, screen design, and specifications were kept the same as those of the EOS-1D Mark III.

Shooting functions are now assigned to 3 buttons above the LCD panel. Through these buttons, the most frequently-changed settings are now accessible near the Main Dial. As with the EOS-1D Mark III, one uses the Main Dial to change ISO speed, AF mode, and metering mode. The Quick Control Dial is used to change flash exposure compensation, drive mode, and white balance. The menu operation method is also now the same as with the EOS-1D Mark III. Canon is making camera operation methods as uniform as possible throughout their professional and advanced amateur ranges.

Layout of Shooting Buttons

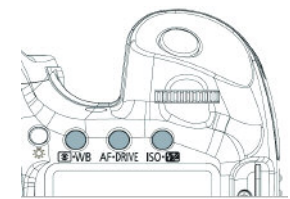

The new interchangeable focusing screens, 2-sec. self-timer, sRAW file format, My Menu, camera setting registration, Live View Function, 3.0-in. LCD monitor with wider color gamut and enhanced information display (ISO always displayed, LCD monitor also used to display settings of shooting functions) all make the EOS 40D easier to use, more flexible and more controllable in an unlimited range of conditions and circumstances.

Camera Setting Display

The EOS 40D has a shooting function setting display on the LCD monitor. Setting details can be verified in the large text display. This feature is also effective when the upper display panel is difficult to see, such as when it is in an elevated position during tripod use.

Shooting Function Setting

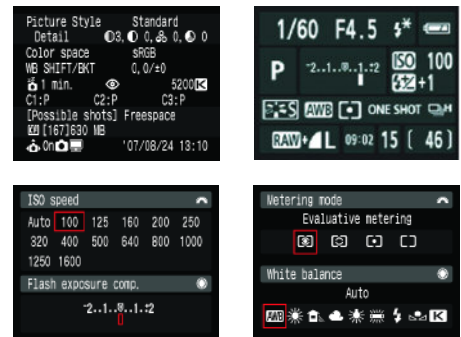

Press the INFO. button to change the screen as follows:

1. Camera settings display
2. LCD panel display
3. Display off

INFO Display

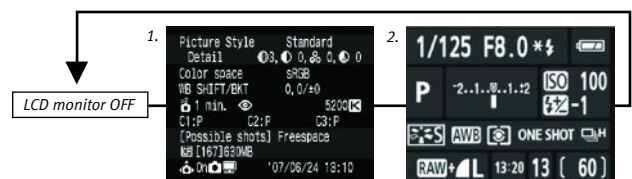

With the LCD panel display that appears after pressing the INFO. Button twice, pressing one of the top buttons, such as ISO speed/flash exposure compensation, will display the respective setting screen, as in the manner of the EOS Digital Rebel XTi.

Setting Screens

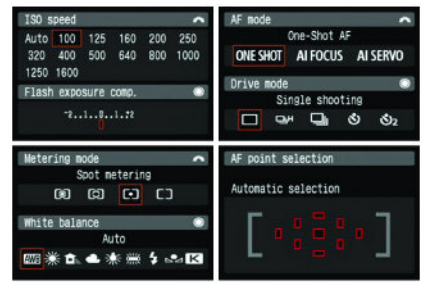

Because the EOS 40D does not have a display-off sensor, press the INFO. button to turn on/off the INFO display. If auto power off is [Off] and the camera is left idle, the LCD monitor will turn off automatically after 30 min., but the camera power does not turn off.

Menu Setting Display

As in the case of the EOS-1D Mark III, one turns the Main Dial to select the menu tab and turns the Quick Control Dial to select menu options. The Multi-controller can also be used for menu operations.

Menu Options



The menus are: Shooting, Playback, Set-up, Custom Function and My Menu. They are now available in 18 different languages with the addition of Greek, Polish and Portuguese.

Playback Display

Changes in playback display follow features introduced with the EOS-1D Mark III. During single-image playback, pressing the <INFO.> button switches the shooting information screen in the sequence shown here. One can also set the menu option to display the overexposed highlight warning and now, as well, the AF point that achieved focus. There are 2 types of single-image full display and, also new, 2 types of shooting information display.

Information Display Sequence

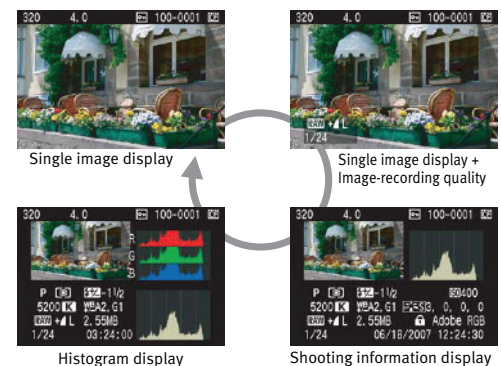

In addition to the 9-image index display, a 4-image index display is now provided.

Press the <JUMP> button, then turn the Quick Control Dial to select the jump method (jump by 1 image, 10 images, 100 images, 1 screen, or shooting date).

Jump Display



With the [Erase images] menu, select [Select and erase images] and checkmark the images to be erased. Then all the checkmarked images can be erased at one time.

Erase Images Screen

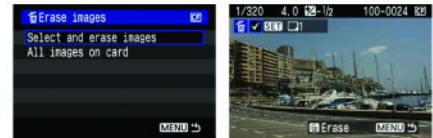

My Menu The My Menu feature keeps track of frequently modified menu items for quick and easy setting. One can register up to 6 of the most frequently-set menu options and Custom Functions under My Menu. Also, when [Display from My Menu: Enable] is set, pressing the Menu button will first display the My Menu screen (tab). One can also use EOS Utility to set My Menu and register it to the camera.

Camera User Settings The EOS 40D's shooting function settings and menu settings can be registered to the Mode Dial's C1, C2, or C3 positions. Except for date/time and other settings which need not be registered, almost all the camera settings can be set here.

Register Camera User Settings

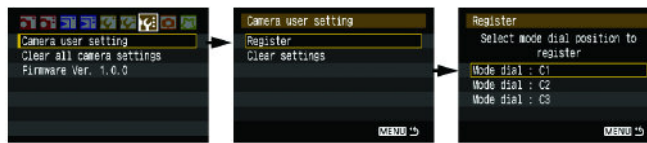

Camera User Settings

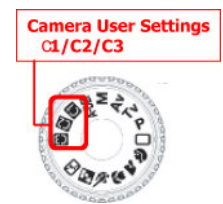

AF-ON Button The EOS 40D has several functions that were added to support the wide variety of shooting styles expected of users of this camera. The AF button is placed in a convenient position for access by the frequently-used right thumb. The button is effective when users want to focus and decide exposure separately. The AF-ON button is used to operate AF, and pressing the shutter halfway down can fix the exposure.



Pressing the AF-ON button also pauses Live View Function (reflex mirror goes down) and executes AF. Letting go of the AF-ON button resumes the Live View Function.

Picture Style Button The EOS 40D's Picture Styles have the same specifications as those of the EOS 30D. The EOS 40D has a separate Picture Style selection button positioned conveniently at the bottom right of the LCD monitor to make selection easier.

Picture Style Button



Picture Style Selection Screen

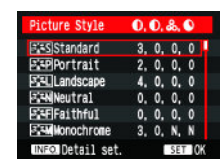

Customization The EOS 40D can be configured with speed, convenience and assurance in many, many ways. The EOS 40D has 24 Custom Functions with 62 settings selectable with the camera. Current camera user settings can be registered under the Mode Dial's C1, C2, and C3 settings. Up to 6 top-tier menu options and Custom Function settings can be registered in My Menu. With the Speedlite 580EX II attached to the camera, one can set or cancel all the Speedlite's Custom Function settings (C.Fn-0 to 13) with the camera.

Camera Direct Printing

Two useful additions have been made to printing direct from the camera. First, a preview display shows effects such as B/W, Vivid, Brightness correction, Hue, and Adjust levels before printing. The feature is not enabled for face brightener or red-eye correction.

Then, tilt angle correction adjusts the angle of images shot with a tilt to print horizontally. With the trimming screen, turn the Quick Control Dial to tilt the image up to ± 10 degrees in 0.5° increments.

As with the EOS-1D Mark III, RAW, sRAW and JPEG printing and Red-Eye 1 are provided. Camera Direct Printing is now compatible only with PictBridge. Bubble Jet Direct and CP Direct are not supported.

Print order (DPOF) and direct image transfer are the same as with EOS 30D.

Printing Effects

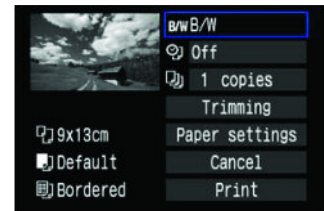

Tilt Correction



Interface

USB 2.0 Hi-Speed is provided for the interface with personal computers and camera direct printing. Additionally, the camera bottom has an extension system terminal, principally for the Wireless File Transmitter WFT-E3A. The other terminals, including PC socket for non-dedicated external flash units, as well as video out and N3-type remote control, are the same as those on the EOS 30D.

Terminals



Extension System Terminal



Power: Sources and Management

The power source system is the same as the EOS 30D's and uses the Battery Pack BP-511A. With a fully-charged battery, the number of possible shots without flash use is about 1100 at $73^\circ\text{F}/23^\circ\text{C}$. With 50% flash use, it is about 800 shots. As with the EOS 30D, the date/time backup battery is the lithium battery CR2016 installed in the battery compartment. Detaching and attaching the battery compartment cover is now easier. One pulls it out or puts it back at a 45° angle.

Battery Compartment Cover

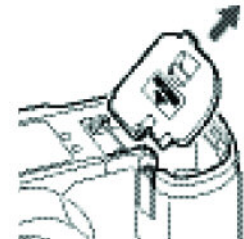

With the Battery Grip BG-E2N, 2 battery packs or 6 AA-size batteries can be used.

To minimize the higher power consumption required by 4-channel, high-speed signal reading, the output amp's power usage has been kept to an absolute minimum. Also, as in the case of the EOS Digital Rebel XTi, to save energy during long exposures, power to the output amp is turned off and the standard current driving the circuit is also cut off. During Live View Function, power distribution for the signal-reading operation is optimized, as with the EOS-1D Mark III. Such measures enable more precise power-saving control.

V. SOFTWARE

Consistent with Canon's practice of providing a complete software package at no additional expense to purchasers of its Digital SLR cameras, the EOS Digital Solution Disk Ver.15 is included with the EOS 40D camera. It includes Picture Style Editor Ver.1.0 a new program discussed here. The other software on the disk has been upgraded for EOS 40D compatibility, including RAW files. EOS Utility Ver.2.1 allows folder monitoring with the Wireless File Transmitter WFT-E3A and link-ups with Picture Style Editor.

"Picture Style" was first included as part of EOS Digital in the fall of 2005. Since then, it has become a standard feature in EOS Digital and will be incorporated into the entire current EOS product range in the latter half of 2007. These features, namely:

- the standardization of image characteristics across all EOS Digital models
 - optimized support for photographic expression according to purpose
 - support for RAW images shot on older models in DPP
 - support for web downloading of Picture Style files according to purpose,
- have been very well received by users. That said, there have also been calls from advanced users with particularly stringent demands in terms of image processing for even more flexible adjustments that go beyond the preset characteristics supplied by Canon.

The Picture Style Editor, as the name suggests, is software that allows users to create their own Picture Style files. To create his or her own Picture Style file, the user selects and loads a sample RAW image and then adjusts the image characteristics based on one of the existing Picture Style settings (Standard, Portrait, Landscape, Neutral or Faithful) except for Monochrome. The created Picture Style file can then be registered in the camera using EOS Utility or used in the DPP or RAW Image Task applications.

Settings that can be adjusted in Picture Style Editor:

- a. Existing Picture Style Detail settings: Color Tone, Color saturation, Contrast and Sharpness adjustments
- b. Color specification and individual minute adjustments to specified colors: selection of a specific color in the sample image and adjustment of the hue, saturation and Luminosity, as well as minute adjustments to the gamma characteristics (tone curve)

The settings in a. were previously available either on the camera or in EOS Utility, so that the results of any adjustments had to be checked later after the picture had actually been taken. With Picture Style Editor, the results of adjustment can be checked in real time. The adjustments in b. are available for the first time (with real time checking) with Picture Style Editor. Up to 100 color points can be selected in the color specifications provided in b.

PSE Main Window and Tool Palette



Picture Style Editor ver.1.0 supports RAW images shot only on the EOS 40D. (Future versions will support future EOS models, but no reverse compatibility to older EOS models is planned.) Picture Style Editor has a Preliminary Adjustment window for images that need supplementary adjustment.

Preliminary Adjustment Window

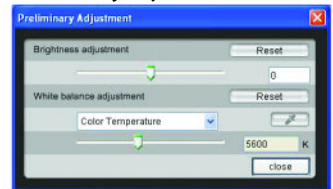

For images shot with the correct exposure/white balance, there is no need to use preliminary adjustment.

The editing window consists of 3 components:

- Main window: Displays the sample image
 - Navigator window: Displays the position of a magnified image and also displays histograms
 - Tool palette: Provides the adjustment functions
- Because the adjustments made using the tool palette functions are applied immediately to the sample image shown in the main window, one can check the results in real time.

Main Windows in PSE

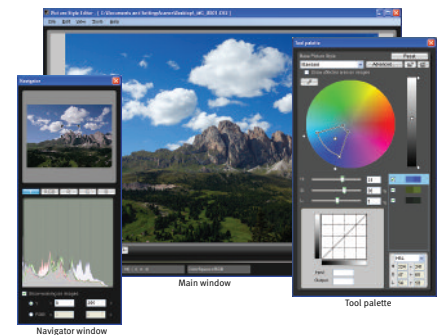

The functions of the main window are as follows:

- Display mode switching: Normal view (single image display) and before and after adjustment comparison display (top/bottom split or left/right split)
- Image rotation: Left or right in 90° increments
- Display magnification switching: Full view, 12.5%, 25%, 50%, 100% and 200%
- Cursor coordinates position and RGB values (8-bit conversion) display
- Work color space display

Note that the sample image is processed and displayed using the camera settings used when the picture was taken. Adjustments made in DPP or RAW Image Task after shooting are not applied to the sample image.



Main window before and after adjustment comparison display, top/bottom split

The Navigator window supplements the operations performed in the main window and tool palette and offers the following functions:

- Enlargement display position shows the position displayed when the sample image in the main window is enlarged. One can also use this window to drag the enlargement display position around. The sample image in the main window changes in response.
- Histogram display shows the distribution of luminance and color components in the sample image displayed in the main window. The histogram display can be switched using the [Y] (luminance), [RGB], [R], [G] and [B] buttons.
- Warning indicator flashes if one enters or sets upper and lower limits in these fields and there are areas in the sample image displayed in the main window with values that exceed those limits.

One can choose either [Y] (luminance) or [RGB] (color value) as the warning to be used.

Navigator Window

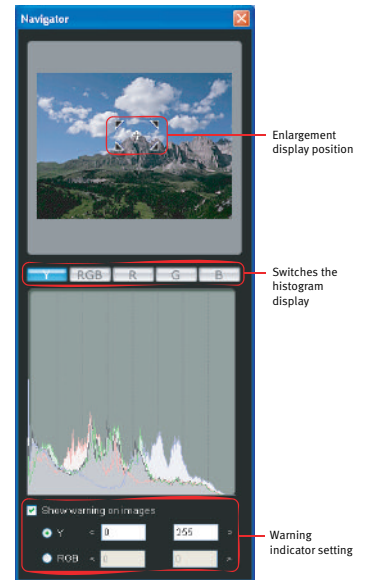

The functions of the tool palette are as follows:

- Selecting the Picture Style used as the basis for one's new Picture Style
- Adjusting the color tone, color saturation, contrast and sharpness
- Making minute adjustments to a specified color (hue, saturation and luminosity)
- Adjusting the gamma characteristics

Note that Picture Style Editor uses the DPP algorithms for image processing. This means that the color tones produced by tool palette adjustments tend to be the same as those made in DPP.

Tool Palette

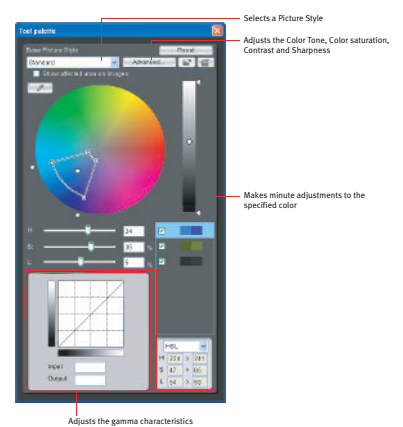

One can choose any of the Picture Style settings (Standard, Portrait, Landscape, Neutral or Faithful, but not Monochrome) as the starting point for Picture Style to be used as a basis. One can also download and select one of the purpose-made Picture Style files (e.g. Emerald) from the Canon website. One can then adjust the color tone, color saturation, contrast and sharpness.

Panel for Minute Color Adjustment

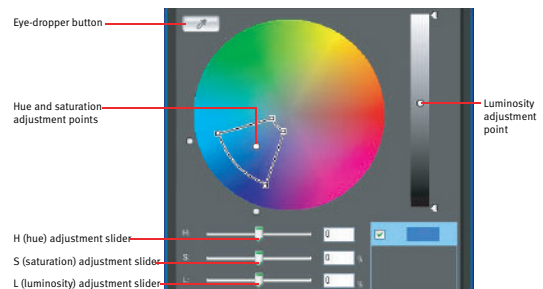

A panel is provided for minute color adjustment. The panel permits the user to set the range of possible adjustment.

One can specify up to 100 color adjustment points, and the adjusted colors will be displayed on the adjustment color list. The adjustment color list displays and their functions are as follows:

- Colors before and after adjustment
- Apply/Do not apply checkbox
- Range of effect overlap indicator

The range of effect overlap indicator is displayed if the range of effect of an adjusted color overlaps the range of effect of another adjusted color. Colors in overlapping ranges are displayed in gray on the color wheel and adjusted using an aggregated value for the respective adjustments. To avoid overlapping ranges, one must reset the ranges of effect so that they no longer overlap. Also, one can delete an adjusted color by selecting the color in the adjustment color list and pressing the key on the keyboard.

Adjustment Color List

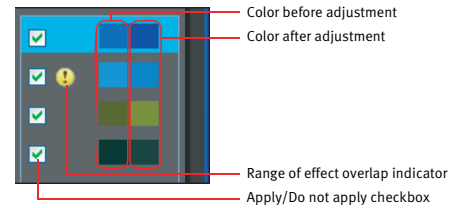

There are 3 color display modes from which to choose: HSL, Lab or RGB. Color values are displayed in the appropriate panel.

Color Display Modes and Color Value Displays

Switches the color display mode

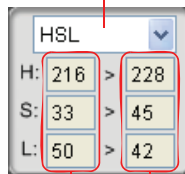

Color value before adjustment

Color value after adjustment

Display with Each Color Display Mode

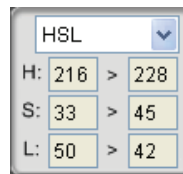

HSL mode

A color mode in which colors are represented in terms of 3 factors: H (Hue), S (Saturation) and L (Luminosity).

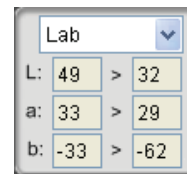

Lab mode

A color mode developed by the CIE (Commission Internationale d'Eclairage) where "L" denotes lightness, "a" denotes the color elements from green and "b" denotes the color elements from magenta from blue to yellow.

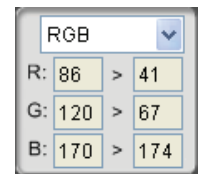

RGB mode

A color mode in which colors are represented using the three primary colors (and the additive color mixtures) of the visible light spectrum: red (R), green (G) and blue (B).

One can adjust the gamma characteristics of an image using the tone curve. By creating up to 10 adjustment points anywhere along the tone curve, one can freely adjust brightness and contrast. The results of the adjustments are applied to the sample image in the main window in real time.

Adjusting the Gamma Characteristics

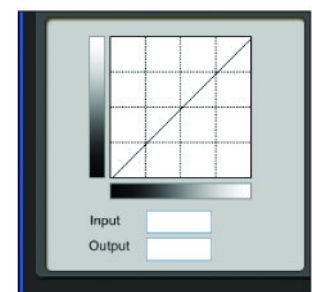

One can save all the adjustments one has made with the tool palette as an original Picture Style file (with the .PF2 extension). (Because adjustments made in Picture Style Editor are saved in Picture Style files, they are not saved in the sample image used for the adjustment process.) Adjustments are saved in the save window, which appears when you click the save window display button in the tool palette. When one saves the file, there is a [Disable subsequent editing] checkbox that prevents disclosure of the adjustments made in Picture Style Editor as well as any captions or copyright information. Picture Style files that have been saved with the [Disable subsequent editing] checkbox ticked can be used in cameras and in DPP in the same way as ordinary Picture Style files. However, because they can no longer be opened in Picture Style Editor, one cannot check the adjustments. (We recommend also saving a separate copy of the Picture Style file without the [Disable subsequent editing] checkbox ticked.)

Like purpose-made Picture Style files downloaded from the Canon website, saved Picture Style files can be registered and used in cameras and used in the DPP and RAW Image Task applications.

- (1) Using Picture Style files in cameras: One can use EOS Utility to register a Picture Style file in a camera equipped with the Picture Style function and then apply the file to photographed images.
- (2) Using Picture Style files with DPP: One can use DPP to apply Picture Style files to any compatible RAW image.
- (3) Using Picture Style files with RAW Image Task: One can use RAW Image Task to apply Picture Style files to RAW images shot on cameras equipped with the Picture Style function.

Picture Style Editor will be included on EOS Digital Solution Disk ver.15. Later this year, Picture Style Editor will be available as a download for all EOS users from the Canon website.

VI. ACCESSORIES AND LENS

Battery Grip BG-E2N The BG-E2N is a high-capacity battery grip dedicated to the EOS 40D. It was developed to enable high-volume shooting and easier vertical shooting. It can accommodate the BP-511A as well as AA-size batteries.

In terms of function, the BG-E2N is the same as Battery Grip BG-E2 for EOS 30D, 20D, and 20Da. However, the battery compartment cover now has sealing material to make it more resistant to dust and water than the BG-E2. The power source and method are the same as with the BG-E2. With the introduction of the BG-E2N, the BG-E2 will be discontinued. Therefore, the BG-E2N will be the battery grip for the EOS 30D, 20D, and 20Da henceforth. When the BG-E2N is attached to these cameras, the continuous shooting speed and number of possible shots will be the same as with the BG-E2.

Features:

- (1) The EOS 40D (with BP-511A x 2) enables about twice as many shots to be taken when compared with shooting with one battery
- (2) Compatible with size-AA batteries
- (3) Makes vertical shooting as easy as horizontal shooting
- (4) AC power can be supplied via the ACK-E2 AC power adapter or the CA-PS400 + DR-400
- (5) The battery compartment cover has new sealing material to improve resistance to dust and water
- (6) Hand Strap E1 (sold separately) attachable



Wireless File Transmitter
WFT-E3A

The WFT-E3A is a dedicated EOS 40D accessory similar to the WFT-E2A (the wireless file transmitter unit for the EOS-1D Mark III) offering wireless or wired network functions (via FTP, PTP, or HTTP) and support for USB peripherals (specifically, external storage devices and GPS units). There are 2 main differences from WFT-E2A: inclusion of controls for vertical shooting and inclusion of the unit's own power supply. Compared with the WFT-E1A, communication speed is 1.5x faster (wireless) and 3x faster (wired).

For better control of the EOS 40D when shooting with the WFT-E3A attached, the unit provides vertical grip functions. In the same way as when a battery grip such as a BG-E2N, is attached, the WFT-E3A feels well integrated with the camera. The internal antenna offers a wireless range equivalent to that of the WFT-E2A, up to about 492 ft./150m. Like the battery grip, the WFT-E3A attaches to the camera's tripod socket.

Wireless and wired LAN function specifications are the same as for WFT-E2A. Note that the camera graphic on the WFT Server screen during HTTP connections has been updated from EOS-1D Mark III to EOS 40D. Requirements for external media or GPS devices that can be connected are the same as for the WFT-E2A. Note that images cannot be copied between media.

Features:

- Ideally shaped; does not interfere with shooting:
 - Attaches directly to the bottom of the EOS 40D (cordless)
 - Internal antenna (wireless range: approx. 492 ft./150m)
- Faster image transfer:
 - Wireless networks: 1.5 times faster than WFT-E1A (IEEE 802.11g)
 - Wired networks: 3 times faster than WFT-E1A (Ethernet 100 Base-TX)

WFT-E3A



- Offers FTP, PTP, and HTTP communication modes:
 - FTP: Image transfer over wireless or wired networks to an FTP server
 - PTP: Communication between EOS Utility and the camera over wireless or wired networks
 - HTTP: Remote capture over wireless or wired networks using a web browser
- Better user support in configuring wireless or wired network settings:
 - Wizard-based configuration of transfer settings through the camera GUI
 - Includes features for network detection and automatic setup (access point detection and automatic acquisition of IP address)
 - Supporting software for PTP connections
- Compatible with external storage devices and GPS units (USB connection):
 - Users can connect external hard disks or other external storage devices
 - GPS data can be added to images
- Includes controls for vertical shooting

Focusing Screen Ef

The Ef-series focusing screens are interchangeable focusing screens developed for the EOS 40D. 3 types are available: Ef-A Standard Precision Matte, Ef-D Precision Matte with Grid, and Ef-S Super Precision Matte to make it easy to see the point of focus. The optical characteristics of the Ef-A and Ef-D focusing screens are the same as the Ee-A and Ee-D focusing screens. The optical characteristics of the Ef-S focusing screen are the same as the Ec/Ee-S focusing screens. The focusing screen can be installed in the same way as previous focusing screens. However, to make them easier to install, a dedicated tool has been newly developed. The tool case is the same as the one for Ec/Ee focusing screens and has a paper partition matching the Ef-series focusing screen.

Ef-A Standard Precision Matte

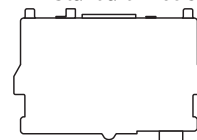

Ef-D Precision Matte Grid

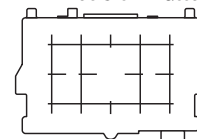

Ef-S Super Precision Matte

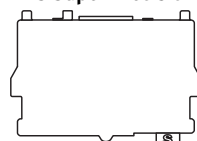

The Ef-series focusing screens are smaller than the old focusing screens. The new installation tool is longer than the old one with the lever more toward the rear, making it easier to install and remove the new focusing screen.

Comparison of Focusing Screen Size

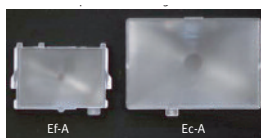

Comparison of Tools

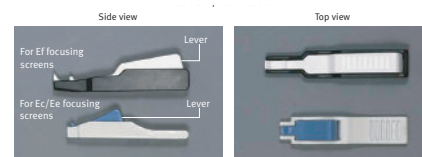

New IS Lens The Canon EF-S 18-55mm f/3.5-5.6 IS is a standard zoom lens specifically for cameras that take EF-S lenses. It was developed in response to market demand for a zoom lens equipped with Image Stabilizer technology at a reasonable price.

The advantages of IS in the lens are, first, that each IS system can be designed and optimized for its specific application, yielding a level of performance unattainable by the in-body, shifting sensor technique. Second, one can see the image stabilization effect in the finder. The image is steady; accurate framing is possible; the AF point can be placed precisely, and the photographer can concentrate on the shot and capture the best moment. Panning is also easier and more effective than with the in-body approach.

While it is roughly equivalent in weight and size to the EF-S 18-55mm f/3.5-5.6 II/ f/3.5-5.6 II USM, it offers an image stabilization effect equivalent to a shutter speed of 4 stops faster, giving it superb specifications as well as a modest and attractive price.

Image Stabilization with Shifting Elements

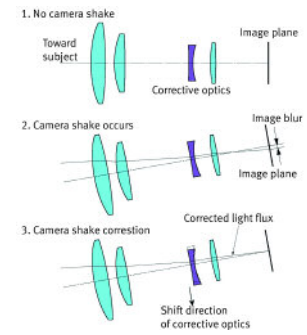

External View and Cross Section of EF-S 18-55mm f/3.5-5.6 IS

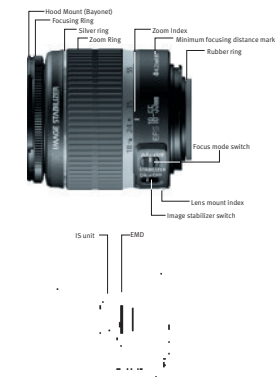

The EF-S 18-55mm f/3.5-5.6 IS lens features:

- Light and compact IS-equipped standard zoom lens specifically for cameras that take EF-S lenses (For EOS 40D, EOS 30D, EOS 20D, EOS 20Da, EOS Digital Rebel XTi, EOS Digital Rebel XT and EOS Digital Rebel only, as of August 2007)
- Uses smaller circuit boards and a downsized IS unit to make a Canon Image Stabilizer lens that is roughly the same size and weight as the EF-S 18-55mm f/3.5-5.6 II/ f/3.5-5.6 II USM
- High-speed autofocus features high-speed CPU and optimized AF algorithm
- Image Stabilizer effect equivalent to a shutter speed about 4 stops faster
- Uses a high-precision PMo aspherical element to correct aberration for excellent image quality throughout the zoom range

EF-S 18-55mm f/3.5-5.6 IS Lens Movement During Zooming

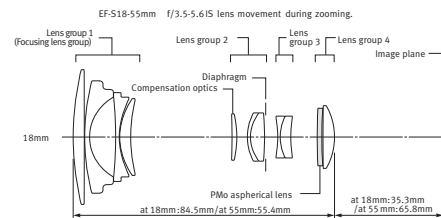

Optical Construction EF-S 18-55mm f/3.5-5.6 IS

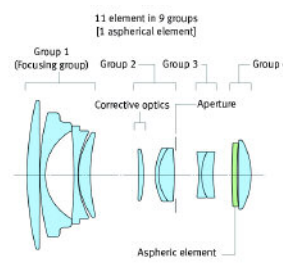

- Compensation optics lens barrel suspended by 3 springs that hold it in place in the center, making it possible to eliminate the compensation optics retaining mechanism in this IS unit

**IS Unit for
EF-S 18-55mm F3.5-5.6 IS**

**IS Unit for
EF 70-200mm F2.8L IS USM**

* It is this structure also about EF-S55-250mm f/4-5.6 IS.

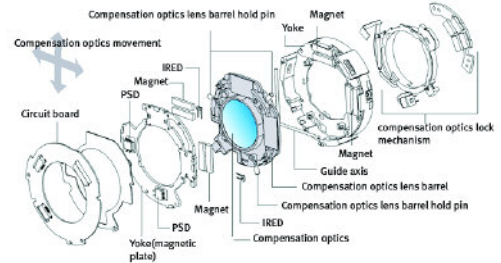
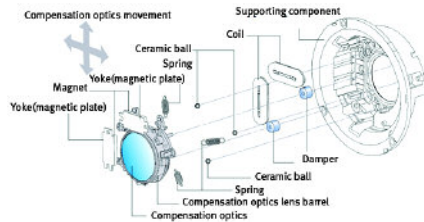

- Orientation of the compensation optics lens barrel along the optical axis maintained using the force exerted by angle-mounted springs and ceramic ball bearings (The rotation of these ceramic ball bearings ensures that the corrective optics are driven smoothly)
- Silicone resin damper fitted between the compensation optics lens barrel and the supporting component (lens group 2 lens barrel) damps harmful vibrations caused by the extension and contraction of the springs and improves IS performance
- Drive actuator for the compensation optics lens barrel constructed using the same permanent magnets and coils used in existing IS units
- Construction of the new unit is based on the IS mechanism used in the PowerShot SD700 IS Digital ELPH with design optimized for the characteristics of this lens
- Incorporating part of the lens group 2 lens barrel as a component of the IS unit makes it possible to install the IS mechanism in a very limited space
- Automatically distinguishes between normal shooting and panning shots and selects the optimum Image Stabilizer mode, a first for Canon IS lenses—vibration gyro used to detect the difference between normal camera shake and panning movement—MODE 1/Normal and MODE 2/panning eliminated
- A tripod can be used with IS left ON (but switching OFF will still reduce power consumption)
- Minimum focusing distance of 0.25m at all zoom settings
- Maximum magnification is 0.34x (at 55mm)
- Uses round EMD diaphragm for very good background blur quality (bokeh) and round points of light

Structural Diagram of the IS Unit Used in the EF-S 18-55mm f/3.5-5.6 IS (schematic)

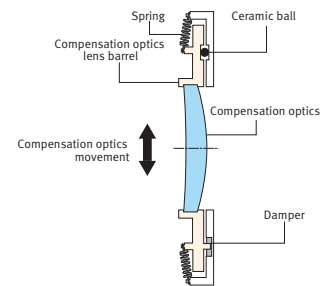

- Flare and ghosting minimized by optimized lens configuration and coating

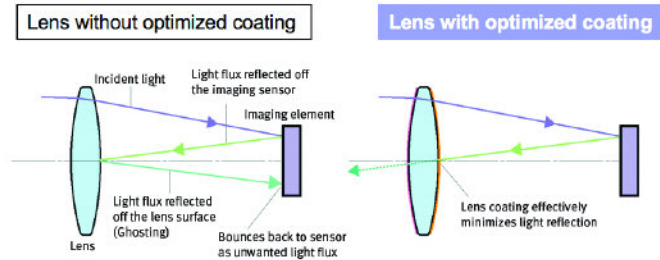

- Optical system constructed using only lead-free glass
- Improved feel and handling from new exterior design with L-series type paint finish, finer zoom ring grip pattern and re-shaped switch panel
- 5 types of EOS-dedicated information signal transmission: lens status, lens type, metering information, focal length, AF drive info
- Rubber ring on rearmost lens surface to prevent damage to lens or camera
- Back of lens mechanically configured to prevent mounting mistakenly on cameras that do not accept EF-S lenses
- Made in Japan by Oita Canon

Zoom Ring Pattern

Change to the grip pattern used in EF lenses.



EF-S 18-55mm
f/3.5-5.6 II



EF-S 18-55mm
f/3.5-5.6 IS

SW Panel

To prevent accidental switch operation, the shape of the switch has been changed.



EF-S 18-55mm
f/3.5-5.6 II



EF-S 18-55mm
f/3.5-5.6 IS

VII. SPECIFICATIONS

- Type of Camera** **Type:** Digital AF/AE SLR
Recording Media: CF Card Type I and II and external media (USB v.2.0 hard drive, via optional Wireless File Transmitter WFT-E3A)
Image Sensor Size: 0.87 x 0.58 in./22.2 x 14.8mm (APS-C size sensor)
Compatible Lenses: Canon EF, EF-S, TS-E, and MP-E lenses
Lens Mount: Lens Mount: Canon EF mount
Lens Focal Length Conversion Factor: 1.6x
- Image Sensor** **Type:** High-sensitivity, high-resolution, single-plate, CMOS sensor
Effective Pixels: Approx. 10.10 megapixels
Total Pixels: Approx. 10.50 megapixels
Aspect Ratio: 3:2 (Horizontal : Vertical)
Color Filter System: RGB primary color filters
Low-pass Filter: Fixed position in front of the CMOS sensor
Dust Delete Feature: (1) Self Cleaning Sensor Unit, (2) Dust Delete Data, (3) Manual Sensor Cleaning
- Recording System** **Recording Format:** DCF 2.0 (Exif 2.21): JPEG, RAW and RAW+JPEG simultaneous recording possible. Multiple options for recording images on a memory card, and onto compatible external USB hard drives (via optional Wireless File Transmitter WFT-E3A)
File Size on CF Card: (1) JPEG/Large: Approx. 3.5MB (3,888 x 2,592), (2) JPEG/Medium: Approx. 2.1MB (2,816 x 1,880), (3) JPEG/Small: Approx. 1.2MB (1,936 x 1,288), (4) RAW: Approx. 12.4MB (3,888 x 2,592), (5) sRAW: Approx. 7.1MB (1,936 x 1,288)
File Numbering: (1) Continuous numbering (2) Auto reset (3) Manual reset (the image numbering is reset to 0001, a new folder is created and selected automatically)
Color Space: Selectable between sRGB and Adobe RGB
Picture Style: Six preset Picture Style settings plus three user-defined custom Picture Style settings with individual adjustments for Sharpness, Contrast, Saturation, Color tone; Filter effect, Toning effect for black & white images
- White Balance** **Settings:** Auto, Daylight, Shade, Cloudy, Tungsten Light, White Fluorescent Light, Flash, Custom WB setting, user-set Color Temperature (2,500~10,000K)
Auto White Balance: Auto white balance, taken from imaging sensor
Color Temperature Compensation: White balance bracketing: Three consecutive files written from one exposure: Up to +/- 3 levels in 1-step increments; White balance shift: blue/amber bias and/or magenta/green bias +/- 9 levels; manually set by user

Viewfinder **Type:** Eye-level SLR with fixed pentaprism
Coverage: Approx. 95% horizontally and vertically
Magnification: 0.95x (-1 dpt with 50mm lens at infinity)
Eyepoint: Approx. 22mm
Dioptric Adjustment Correction: -3.0 to +1.0 diopter
Mirror: Quick-return half mirror (Transmission: reflection ratio of 40:60)
Viewfinder Information: AF (AF points, focus confirmation light), Exposure (Shutter speed, aperture, ISO speed, AE lock, exposure level, spot metering circle, exposure warning), Flash (flash ready, flash exposure compensation, high-speed sync, FE lock, red-eye reduction light), Image (monochrome shooting, maximum burst, white balance correction, CF card information)
Depth-of-Field Preview: Enabled with depth-of-field preview button; possible in Live View Function

Autofocus **Type:** TTL-CT-SIR AF-dedicated CMOS sensor
AF points: 9 cross-type AF points (f/2.8 at center)
AF Working Range: EV -1 ~18 (ISO 100 at 73°F/23°C)
Focusing Modes: Autofocus (One-Shot AF, Predictive AI Servo AF, AI Focus AF), Manual Focus (MF)
AF Point Selection: Automatic selection, Manual AF point selection
AF-assist Beam: Intermittent firing of built-in flash

Exposure Control **Metering Modes:** 35-zone TTL full aperture metering: (1) Evaluative metering (linked to all AF points), (2) Partial metering (approx. 9% of viewfinder), (3) Spot metering (approx. 3.8% of viewfinder), (4) Center-weighted average metering
Metering Range: EV 0–20 (ISO 100 at 73°F/23°C with EF 50mm f/1.4 USM lens, ISO 100)
Exposure Control Systems: Program AE (shiftable), Shutter-priority AE, Aperture-priority AE, Auto Depth-of-field AE (non-shiftable), Full auto (non-shiftable), Programmed image control modes, Manual exposure, E-TTL II autoflash program AE
ISO Speed Range: Equivalent to ISO 100–1600* (in 1/3-stop or whole stop increments), ISO speed can be expanded to ISO 3200 (* Standard output sensitivity. Recommended exposure index)
Exposure Compensation: Exposure Compensation (user-set): +/-3 stops in 1/3- or 1/2-Stop increments
AE Lock: Auto: Applied in One-Shot AF mode with evaluative metering when focus is achieved; Manual (user-set): By AE lock button in all metering modes

Shutter **Type:** Vertical-travel, mechanical, focal-plane shutter with all speeds electronically controlled
Shutter Speeds: 1/8000 to 30 sec. (1/3-stop increments), X-sync at 1/250 sec.
Shutter Release: Soft-touch electromagnetic release
Self-Timer: 10 sec. delay, 2 sec. delay
Remote Control: Canon N3 type terminal

- Built-in Flash** **Type:** Auto pop-up, retractable, built-in flash in the pentaprism
Guide Number: 43 (feet)/13 (meters), at ISO 100
Recycling Time: Approx. 3 sec.
Flash-ready Indicator: Flash-ready indicator lights in viewfinder
Flash Coverage: 17mm lens focal length (equivalent to 27mm in 35mm format)
Flash Metering System: E-TTL II autofocus
Flash Exposure Compensation: +/-2 stops in 1/3- and 1/2-stop increments
- Drive System** **Drive Modes:** Single, silent, high-speed continuous (approx. 6.5 fps), low-speed continuous (approx. 3 fps), 10- or 2-sec. self-timer
Continuous Shooting Speed: Approx. 6.5 fps (in One-Shot AF and AI Servo AF modes)
Max. Burst During Continuous Shooting: JPEG: approx. 75 frames (Large/Fine); RAW: approx. 17 frames (both during high-speed continuous shooting)
- LCD Monitor** **Type:** TFT color, liquid-crystal monitor
Monitor Size: 3.0 in.
Pixels: Approx. 230,000 pixels
Coverage: Approx. 100%
Brightness Control: 7 levels provided
- Playback** **Image Display Format:** Single image, 4-image index, 9-image index, Jump, Magnified zoom (approx. 1.5x to 10x), Histogram, AF point display, Auto rotate, Rotate
Live View Function: View image before shooting on LCD monitor; live histogram and live simulation of exposure level possible with C.Fn IV-7-1
Highlight Alert: In the single image display and (INFO) display, over-exposed highlight areas will blink
- Image Protection and Erase** **Protection:** Single image or all images in the memory card can be protected or cancel the image protection
Erase: Single image, select images, all images in a CF card or unprotected images
Direct Printing from the Camera: Enabled with the Print/Share button
Compatible Printers: CP and SELPHY Compact Photo Printers, PIXMA Photo Printers and PictBridge compatible printers (via USB Interface Cable IFC-200U, included with camera kit)
Settings: Print quantity, style (image, paper size, paper type, printing effects, layout), trimming, tilt correction
- Menus** **Menu Categories:** (1) Shooting (2) Playback (3) Setup (4) Custom function/My Menu
LCD Monitor Languages: 18 (English, German, French, Dutch, Danish, Portuguese, Finnish, Italian, Norwegian, Swedish, Spanish, Greek, Russian, Polish, Simplified/Traditional Chinese, Korean, Japanese)

Power Source **Battery:** One dedicated Battery Pack BP-511A, AC power can be supplied via the optional AC Adapter Kit ACK-E2
Number of Possible Shots: Normal shooting: approx. 1,100 shots (approx. 800 shots with 50% flash use) at 73°F/23°C, Approx. 950 shots (approx. 700 shots with 50% flash use) at 32°F/0°C. Tests comply with CIPA test standards
Battery Check: Automatic
Power Saving: Provided. Power turns off after 1, 2, 4, 8, 15, 30 min.
Back-up Battery: One CR2016 lithium battery. Battery life approx. 5 years

Dimensions and Weight **Dimensions (W) x (H) x (D):** 5.7 x 4.2 x 2.9 in./145.5 x 107.8 x 73.5mm
Weight (Body only): 26.1 oz./740g

Operating Conditions **Operating Temperature Range:** 32–104°F/0–40°C
Operating Humidity Range: 85% or less

- All the specifications above are based on Canon's Standard Test Method.
- The camera's specifications and physical appearance are subject to change without notice.
- TFT monitor images shown in this white paper are simulated.

VIII. FEATURE COMPARISON CHART

**EOS 40D vs. EOS 30D
Comparison Chart**

Item		EOS 40D	EOS 30D	
Image Sensor	Effective pixels [Approx. pixels]/Image sensor	10.1 million/CMOS	8.2 million/CMOS	
	Effective sensor size [mm]	22.2mm x 14.8mm	22.5mm x 15.0mm	
	Lens crop factor	1.6x		
	Color filter type	Primary colors		
	Low pass filter	3 layers fixed inside		
EOS Integrated Cleaning System		Yes	—	
Recording	Image processor	DIGIC III	DIGIC II	
	A/D conversion	14-bit	12-bit	
	Recording media/Slot type/Quantity	CF card/CF type I, II		
	Supporting 2 GB or greater CF card	Yes		
	Number of recorded pixels (million)	Large/Fine	10.1	8.2
		Middle/Fine	5.3	4.3
		Small/Fine	2.5	2.0
		RAW	10.1	8.2
		sRAW	2.5	—
	JPEG image quality	Fine/Normal		
	Picture Styles	Yes (6 types, 3 styles registered)		
	Color space	sRGB/Adobe RGB		
	RAW + JPEG simultaneous recording	RAW + JPEG	Yes	
		sRAW + JPEG	Yes	—
	Noise reduction function	Long exposure	No/Auto/Yes	
		High-sensitivity shooting	Yes	—
	Highlight Tone Priority	Yes	—	
	Auto correction of brightness and contrast	Yes	—	
	Number of images stored per folder	9999		
	Image number	Serial number/Auto reset/Forced reset		
2GB or greater CF card	Yes			
External recording media	Yes (also for WFT-E3A)	—		
White Balance	Auto white balance (WB)	Yes		
	Preset white balance (type)	6		
	WB correction/WB bracketing	Yes/Yes		
	Manual WB	Image registration in card	Yes/Yes	
Color temperature [K]		2500 ~ 10,000	2800 ~ 10,000	
Viewfinder	Magnification [-1dpt. • 50mm • ∞]	0.95	0.9	
	Coverage [%]	95		
	Standard focusing screen	Precision matte		
	Focusing screen replacement	Yes (2 types)	—	
	Focusing brightness range superimpose display	Yes (9)		
	ISO sensitivity display	Yes	—	
	Monochrome shooting mode display	Yes	—	
	Maximum number of continuous shots display	2 digits	1 digit	
	Eye point	22mm	20mm	
Dioptric adjustment [dpt.]	-3 to +1			
Autofocus	AF points	9		
	Cross-type AF points	9	1	
	Support of central AF points f/2.8	Vertical and horizontal cross detection	Horizontal detection	
	AF frame selection	Multi-controller		
	Focusing brightness range [EV]	-0.5~18		
	AF mode type	3(ONE SHOT/AI SERVO/AI FOCUS)		
	AF speed	○		
	Predictive AF short-distance limit (50Km/h, 300/2.8L)	8m		
	AF start button	Yes	—	
	AF assist light	Intermittent flashing		

**EOS 40D vs. EOS 30D
Comparison Chart
(cont.)**

Item			EOS 40D	EOS 30D	
Exposure Control	Shooting mode [type]		12		
	Sensor zones		35		
	Metering mode	Evaluative	Yes		
		Partial	Yes		
		Spot	Yes		
		Center-weighted average	Yes		
	Metering range [EV]		1–20		
	ISO sensitivity	Auto	Simple shooting zone	Yes (100–800)	Yes (100–400)
			Applied shooting zone		—
		Setting range	Normal	100–1600	
Setting increment			1/3-step		
Extended (C.Fn)		H:3200			
Compensation	System		Manual/AEB		
	Increments and range		1/2, 1/3 • ±2		
Shutter	Speed [sec]		1/8000–30, Bulb		
	Max sync. speed [sec]		1/250		
	Release time lag [ms]		59	65	
	Silent live view shooting		Yes	—	
	One shot > Half-press standby > One shot		Yes		
Flash	Internal flash/GNo.[ISO100 • m]		Yes/13		
	Automatic metering		E-TTL II		
	Flash exposure compensation/FE lock		Yes		
	Flash function setting from menu	Internal flash	Yes	—	
External flash		Yes	—		
Drive	Single/Continuous/Self-timer		Yes		
	Continuous shooting [max. approx. fps]	High speed: H	6.5	5	
		Low speed: L	3		
	Max. burst	JPEG L/Fine	75	30	
		RAW	17	11	
RAW + JPEG		14	9		
Live View Function	Remote Live View		Yes	—	
	(Camera) Live View		Yes	—	
LCD Monitor	Type		TFT		
	Screen size [inches]		3	2.5	
	Number of pixels [About x 10,000]		23		
	Intensity adjustment [levels]		7	5	
	Panel-like shooting information display		Yes	—	
Playback	Display format	1	Yes		
		1 + information [types]	3	1	
		4 + index	Yes	—	
		9 + index	Yes		
	Histogram display (Intensity/RGB)		Yes		
	Highlight warning display		Yes		
	AF frame display		Yes		
	Zoom-in magnification factor		1.5–10		
	Jump display unit	10/100/Shooting date	Yes		
		Index (one screen)	Yes	—	
Enlarged frame feed		Yes			
Rotational display		Auto/Manual			
Image Protection and Erasure	Unit of image protection		1		
	Unit of image erasure	One/All	Yes		
		Selective	Yes	—	
Number of Menu Display Languages		18	15		
Print	Easy print function		Yes		
	CP Direct and BJ Direct		—	Yes	
	PictBridge		○ (Extended function)	Yes	
	DCF/Exif [ver.]		2.0/2.21		
Direct Image Transfer to PC		Yes			
Customize Function	Custom function [types/items]		24/62	19/53	
	Camera user setting		Yes (3)	—	
	My Menu setting		Yes	—	
Addition of Data for Original Image Judgment		Yes			
Error Display	Number display (Display panel)		Yes		
	Message display (LCD monitor)		Yes		

**EOS 40D vs. EOS 30D
Comparison Chart
(cont.)**

Item		EOS 40D	EOS 30D
External Interface	USB Ver.	2.0 Hi-Speed	
	Video output [NTSC/PAL]	Yes	
	Remote control terminal/PC terminal	Yes/Yes	
	Extension system terminal	Yes	—
Exterior/Chassis	Top, front, and rear cover material	Magnesium alloy	
	Chassis materia	Stainless steel	
Shooting endurance [times]		100,000	
Power Source	Battery	BP-511A (BP-511, BP-512, BP-514 acceptable)	
	Shutter count (room temperature)	AE100%	1100
		AE50% FA50%	800
	Startup time [sec]	0.15	
	Battery level display [levels]	4	
	Battery grip/AA dry cell	BG-E2N/Yes	BG-E2/Yes
AC drive	ACK-E2 + DR400		
Size and weight	Size (W x H x D) [mm]	145.5 x 107.8 x 73.5	144 x 105.5 x 73.5
	Weight (exc. battery) [g]	740	700

 =EOS 40D is superior to EOS 30D

IX. CONCLUSION

No product can be perfect for everyone, but the EOS 40D comes pretty close. It has immense appeal to advanced amateurs because of its exceptional image quality combined with an unimposing and convenient operating system. Its reasonable size and weight will travel well (a plus for professionals, too) and fit smaller hands comfortably.

All prospective EOS 40D owners will see a 10.1-megapixel camera that fires long bursts compatible with a vast system of existing pro-grade gear, and makes superb images in almost any light. The heart of the argument? The EOS 40D costs thousands of dollars less than other cameras with fewer features and inferior image quality. It is certain to become a mainstay for entry-level professional photographers and advanced amateurs of virtually every description, as well as a reliable back-up for other pros, who for business and common sense reasons, would prefer less expensive hardware that still gets the job done superbly.

The Canon EOS 40D is a great camera at a great price and is certain to satisfy legions of photographers worldwide.

Contents ©2007 by Canon U.S.A., Inc. All Rights Reserved. Canon, EOS, DIGIC, PIXMA and SELPHY are registered trademarks of Canon Inc. in the United States, and may also be registered trademarks or trademarks in other countries. All other products and brand names are registered trademarks, trademarks or service marks of their respective owners.

Excerpts from this material may be quoted in published product reviews and articles. For further information, please contact Canon U.S.A., Inc. Public Relations Dept., (516) 328-5000